

ME Supplies

Neurology
Accessories and Consumables

Fighting Disease with Electronics

 **NIHON KOHDEN**

EEG selection guide

Electroencephalogram

JE-921A/JE-120A

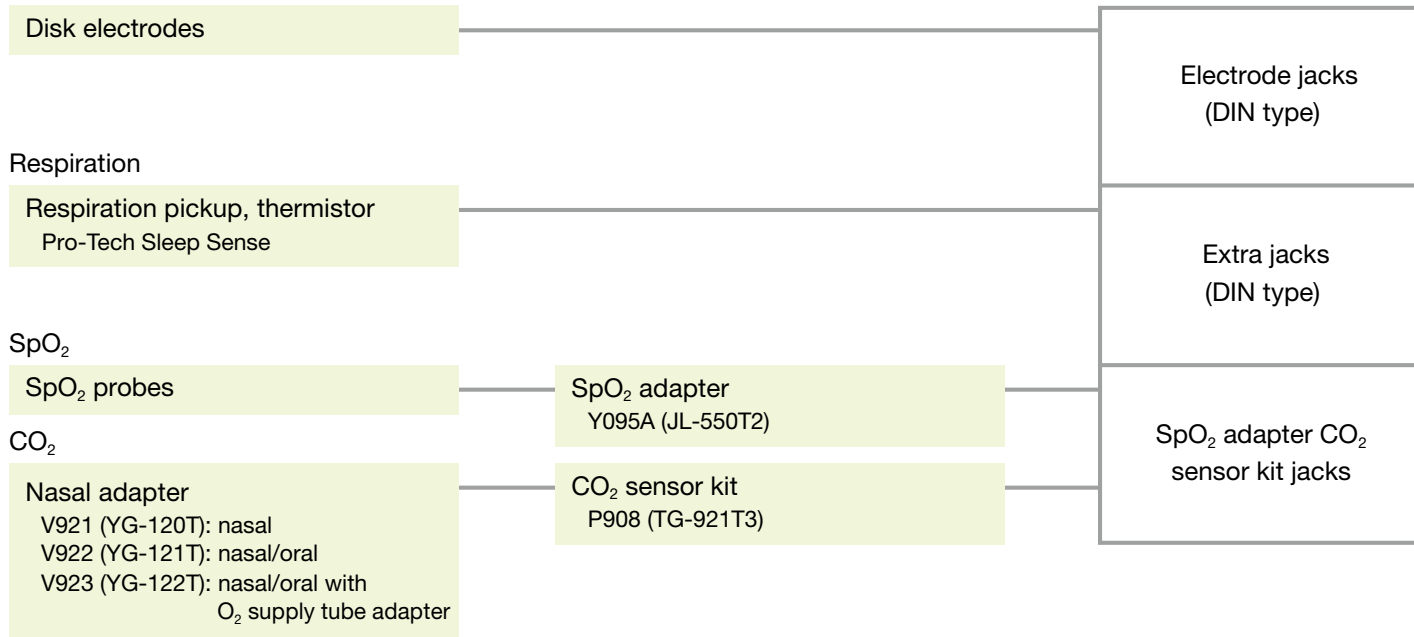

EEG paste

Elefix V EEG paste
from the world's leading EEG manufacturer

ZV-401E03



ZV-181E10



ZV-181E02



Order Code/Model	Volume	Quantity
ZV-401E03	400 g	3 containers
ZV-181E10	180 g	10 tubes
ZV-181E02	180 g	2 tubes

Skin preparation gel

skinPure



Order Code	Model	Volume	Quantity
F020	YZ-0019	135 g	2 tubes

Shielded disk electrodes



Order Code/Model	Quantity
BE-911A	24
BE-912A	12

Disk electrodes



Order Code	Model	Quantity	Length
H503A	NE-113A	26	1.5 m
H503B	NE-114A	26	0.8 m
H503C	NE-116A	26	1.8 m
H503D	NE-117A	6	3 m

Needle electrode



Order Code	Model	Length
H537A	NE-224S	1.5 m

*20 electrodes

Collodion electrode



Order Code	Model	Length
H526	NE-134A	1.5 m
H527	NE-136A	0.7 m

*12 electrodes

Disposable electrode



For aEEG

Order Code	Model	Length
H544	NE-05IS3	0.6m

*5 electrodes/pack × 5 packs

Shield junction cord electrode



For aEEG disposable electrode, disk electrode

Order Code	Model	Length
K640	BM-120A	2.1 m

EEG electrode kit



H467A (BE-403A)



Order Code	Model	Quantity
H541	NE-301B	10

Description	As a kit			For a separate order		
	Order Code	Model	Quantity	Order Code	Model	Quantity
1) EEG electrode lead, 1.5 m	H467A	BE-403A	30 leads/set	K516A	BE-403B	30 leads/set
2) Headcap strap*			1	H564A	BE-0007	1
3) Chin strap*			1	H551A	BE-0008	1
4) Electrode (with plastic holder)			23	H542A	BE-0006	1
5) Electrode pad sheet*			100	H561A	-	100
6) O-ring guide assy and 50 O-rings*			50	H569	-	50
7) EEG ear clip electrode			3	H540A	NE-311A	1 set
8) ECG electrode lead, 2.0 m			2 leads/set	K512A	BC-112B	2 leads/set

*These are accessories



Quick and simple EEG monitoring

Disposable electrodes for EEG



Order Code	Model	Quantity
H548A	NE-091S7	7 pcsx 6 packs



Order Code	Model	Quantity
H548B	NE-090S1	1 pcx 6 packs

EEG disk electrodes



Order Code	Model	Quantity
H503E	NE-118A	Rec 3 pcsx white 3 pcs

Others

Jumper lead



Order Code	Model	Quantity	Length
K617B	NE-430B	5	0.15 m

Adapter

Order Code/Model
Y065

- Non-DIN to DIN

BLUPRO *Reliable SpO₂ probes from the company that invented SpO₂*

Reusable SpO₂ probes



Finger-clip type, 20 kg or more

Order Code	Model	Length
P225F	TL-201T	1.6 m



Multi-site, from neonate to adult, finger or instep

Order Code	Model	Length
P225G	TL-220T	1.6 m



Finger-tip type, 20 kg or more

Order Code	Model	Length
P311C	TL-631T3	1.6 m

Finger-tip type, 50 kg or more

Order Code	Model	Length
P310C	TL-630T3	1.6 m

Single-patient use SpO₂ probes

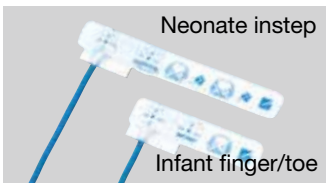
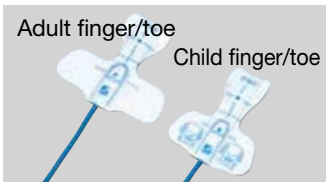

Order Code	Model	Quantity	Length	Applicable for
P203A	TL-271T	24	0.8 m	Adult finger/toe
P203E	TL-271T3	24	1.6 m	
P203B	TI-272T	24	0.8 m	Child finger/toe
P203F	TI-272T3	24	1.6 m	
P203C	TL-273T	24	0.8 m	Neonate instep
P203G	TL-273T3	24	1.6 m	
P203D	TL-274T	24	0.8 m	Infant finger/toe
P203H	TL-274T3	24	1.6 m	

SpO₂ adapter



Order Code	Model
Y095A	JL-550T2

• For JE-921A, JE-120A

cap-ONE ORAL NASAL EXPIRATION

CO₂ sensor kit



Order Code	Model
P908	TG-921T3

CO₂ sensor



Order Code	Model
P923	TG-121T

CO₂ adapter



Order Code	Model
K985	JG-921T3

*TG-121+ JG-921T3, for JE-921A, JE-120A

Nasal adapters for non-intubated patients

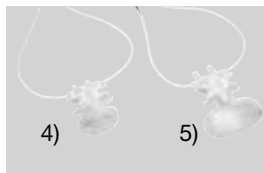
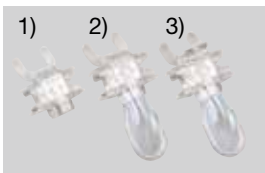

Order Code	Model	Quantity	Usage
1) V921	YG-120T	30	Nasal
2) V922	YG-121T	30	Nasal/oral
3) V923	YG-122T	30	Nasal/oral with O ₂ supply tube adapter
4) V928	YG-125T	10	Nasal/oral with cannula for pressure sensor, adult
5) V929	YG-135T	10	Nasal/oral with cannula for pressure sensor, child

Selection Guide

Evoked EEG

Disk electrodes

H852A (NE-132B), H853 (NE-134B): Collodion type
 H854 (NE-142B): for ABR
 H528 (NE-136B): for stimulation

Evoked electromyogram

Finger electrodes

H653 (NM-450S), H659 (NM-451B)

Surface electrodes

H634 (NM-312S), H638 (NM-315S)

Nerve Conduction Study (NCS)

NCS disposable electrodes

H690 (NM-317Y3), H691 (NM-319Y),
 H692 (NM-316Y), H693 (NM-310Y),
 H694A (NM-314YS), H694B (NM-314YL)

Extension cords

K625A (BM-001B): for 3 electrodes
 K625B (BM-002B): for 2 electrodes

Electrical stimulation

Surface stimulating electrodes

H639 (NM-422B): Adult, stainless
 H636 (NM-420S): Adult, felt
 H635 (NM-410S): Child, felt
 H637 (NM-430S): Variable distance type

Ground electrodes

Ground electrodes, strap type

H662 (NM-501B), H663 (NM-502B),
 H664 (NM-503B), H662A (NM-506B),
 H664A (NM-505B)

Ground electrodes, disk type

H658 (NM-550B), H658A (NM-551B)

Electrode junction box

or

Stimulation unit

or

Main unit

Single-fiber electrode and extension cords

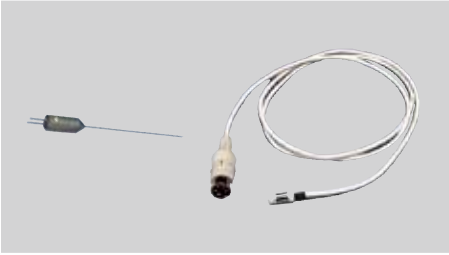

Order Code	Model	Size	Length
H660	NM-640T	Ø 0.45 mm	30 mm
K611	BM-121S	-	1 m

NCS disposable electrodes



Order Code	Model	Quantity	Length	Usage
H690	NM-317Y3	3 pcs × 10 packs	0.2 m	2 recording electrodes, 1 ground electrode
H691	NM-319Y	4 pcs × 10 packs	0.2 m	4 recording electrodes

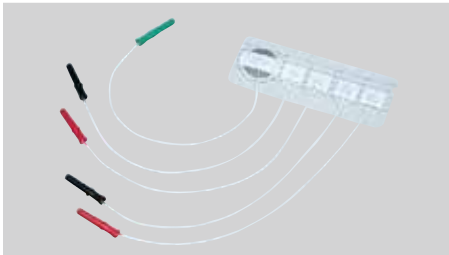

Order Code	Model	Quantity	Length	Usage
H692	NM-316Y	5 pcs × 10 packs	0.2 m	4 recording electrodes, 1 ground electrode



Order Code	Model	Quantity	Length	Usage
H693	NM-310Y	1 pc × 10 packs	1.8 m	1 ground electrode, large



Order Code	Model	Quantity	Length	Usage
H694A	NM-314YS	4 pcs × 10 packs	0.2 m	4 MEP/SEP electrodes
H694B	NM-314YL	4 pcs × 10 packs	1.8 m	4 MEP/SEP electrodes

Extension cord

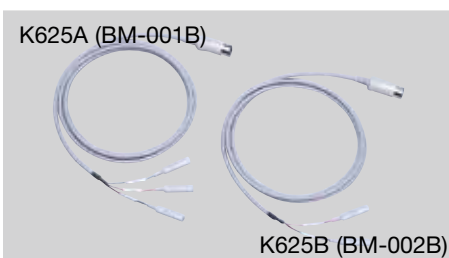

Order Code	Model	Length	Usage
K625A	BM-001B	1.5 m	For 3 electrodes
K625B	BM-002B	1.5 m	For 2 electrodes
K625C	BM-003B	3.5 m	For 3 electrodes
K625D	BM-004B	3.5 m	For 2 electrodes
K629	BM-990W	1.6 m	For stimulation
K629A	BM-990B	3.5 m	For stimulation

Finger electrodes

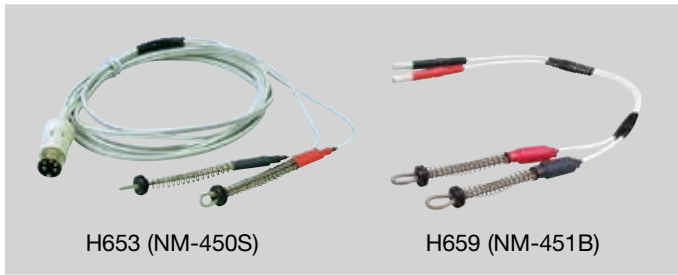

H653 (NM-450S)

H659 (NM-451B)

Extension cables for disposable electrodes

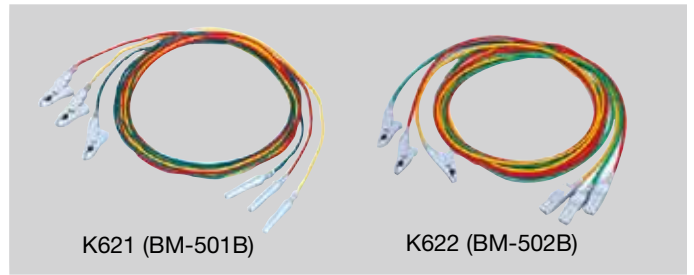

K621 (BM-501B)

K622 (BM-502B)

For MEB-2300

Order Code	Model	Length
H653	NM-450S	2 m
H659	NM-451B	0.3 m

Order Code	Model	Length
K621	BM-501B	1.5 m
K621A	BM-503B	3 m

Order Code	Model	Length
K622	BM-502B	1.5 m
K622A	BM-504B	3 m

Evoked EEG disk electrodes



Order Code	Model	Length
H852A	NE-132B	1.5 m



Order Code	Model
H853	NE-134B

• Collodion type



For ABR

Order Code	Model	Length
H854	NE-142B	0.5 m

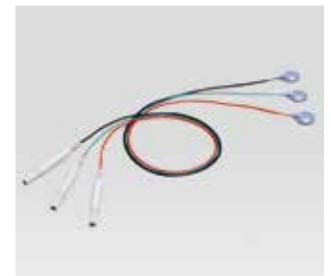

For MEB-2300

Order Code	Model	Length
H528	NE-136B	0.3 m

Surface electrodes



H634 (NM-312S)

Order Code	Model	Length
H634	NM-312S	1.4 m
H638	NM-315S	2.3 m

Extension cords

For EP for MEB-2300



Order Code	Model	Length
K626	BM-910B	3 m

For ABR & Record for MEB-9400



Order Code	Model	Length
K627	BM-911B	3 m

Jumper leads

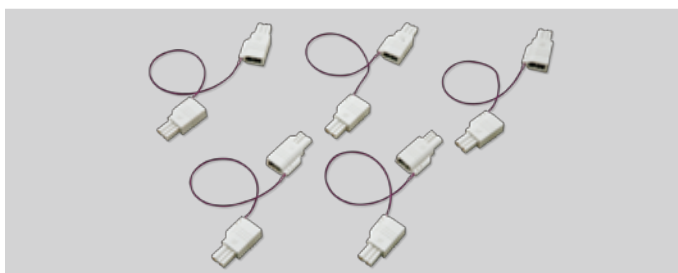

Order Code	Model	Quantity	Length
K617C	NE-432B	5 pcs/set	0.15 m

Temperature probes and insulation pads

Order Code	Model	Quantity
P242D	409J	1
P252	-	60

Surface stimulating electrodes, felt tip



Order Code	Model	Applicable for	Type
H639	NM-422B	Adult	Stainless
H636	NM-420S	Adult	Felt
H635	NM-410S	Child	Felt
H646 ^{*1}	-	-	-
H647 ^{*2}	-	-	-

*1 With NM-420S

*2 With NM-410S

Surface stimulating electrodes



Order Code	Model	Length
H637	NM-430S	2 m

• Variable distance type

Electric stimulator connection adaptor



Order Code/Model	Length
YZ-0172	0.2 m

Ground electrodes, strap type



Order Code	Model	Length	Applicable for
H662	NM-501B	1.5 m	Adult, wrist
H663	NM-502B	1.5 m	Adult, ankle
H664	NM-503B	1.5 m	Child, wrist
H662A*	NM-506B	0.3 m	Adult, wrist
H664A*	NM-505B	0.3 m	Child, wrist

* For MEB-2300

Ground electrodes, disk type



Order Code	Model	Length
H658	NM-550B	1.5 m
H658A*	NM-551B	0.3 m

* For MEB-2300

Headphones



Order Code	Model	Applicable for
Y849A	DR-531B-14	Adult, MEB-2300/9400/9600
Y849B	DR-531B-15	Child, MEB-2300/9400/9600
K101C	—	Extension cable, 5P
Y849C	—	Ear pad

Earphones



Order Code/Model
YE-103J

- 4 sizes of ear tips are included

Order Code	Model	Length
K635A	BM-701B	3.5 m

- Connection cord

For YE-103J

Order Code	Model	Quantity	Usage
Y855A	YE-002A3	20	Earpiece, L
Y855B	YE-002A4	20	Earpiece, M
Y855C	YE-002A5	20	Earpiece, S
Y855D	YE-002A6	20	Earpiece, SS
Y855E	YE-002A7	10	Sound conducting tube

LED goggles



Order Code/Model
LS-102J

Order Code	Model	Length
K635B	BM-702B	3.5 m

• Connection cord for LS-102J

EEG paste

Elefix V



Order Code/Model	Volume	Quantity
ZV-401E03	400 g	3 containers
ZV-180E10	180 g	10 tubes
ZV-181E02	180 g	2 tubes

Skin preparation gel

skinPure



Order Code	Model	Volume	Quantity
F020	YZ-0019	135 g	2 tubes

BLUPRO *Reliable SpO₂ probes from the company that invented SpO₂*

Reusable SpO₂ probes



Finger-tip type,
50 kg or more

Order Code	Model	Length
P310C	TL-630T3	1.6 m

Connection Cords



For JB-110A (PSG-1100),
HB710 (Sphinx PMU710)

Order Code	Model
K931	JL-900P

cap-ONE

ORAL NASAL EXPIRATION

Nihon Kohden's unique sensing technology for both intubated and non-intubated mainstream CO₂ measurement

CO₂ sensor kit



Order Code	Model	Length
P907*	TG-920P	3.5 m



Order Code	Model	Length
P910A	TG-980P	2.9 m

*TG-121+ JG-920P, for JB-110A (PSG-1100)

Nasal adapters for non-intubated patients

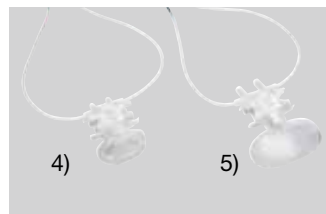
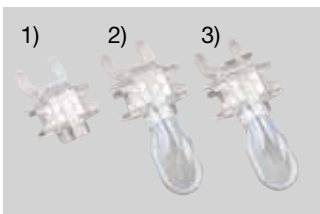

Order Code	Model	Quantity	Applicable for
1) V921	YG-120T	30	Nasal
2) V922	YG-121T	30	Nasal/oral
3) V923	YG-122T	30	Nasal/oral with O ₂ supply tube adapter
4) V928	YG-125T	10	Nasal/oral with cannula for pressure sensor, adult
5) V929	YG-135T	10	Nasal/oral with cannula for pressure sensor, child



Order Code	Model	Quantity	Applicable for
V936A	YG-225T	10	Nasal/oral with cannula for pressure sensor, adult
V937A	YG-235T	10	Nasal/oral with cannula for pressure sensor, child

Some products may not be available in your country.
Contact your Nihon Kohden representative for details.
This brochure may be revised or replaced by Nihon Kohden at any time without notice.



NIHON KOHDEN CORPORATION
1-31-4 Nishiochiai, Shinjuku-ku, Tokyo 161-8560, Japan
Phone +81 3-5996-8041
<https://www.nihonkohden.com/>